

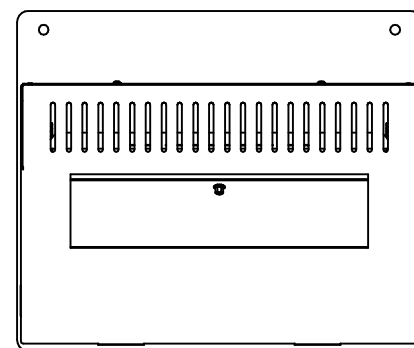

Rev.	Date of issue	Description	Sign
0001	25/07/2025	First edition	T.M.

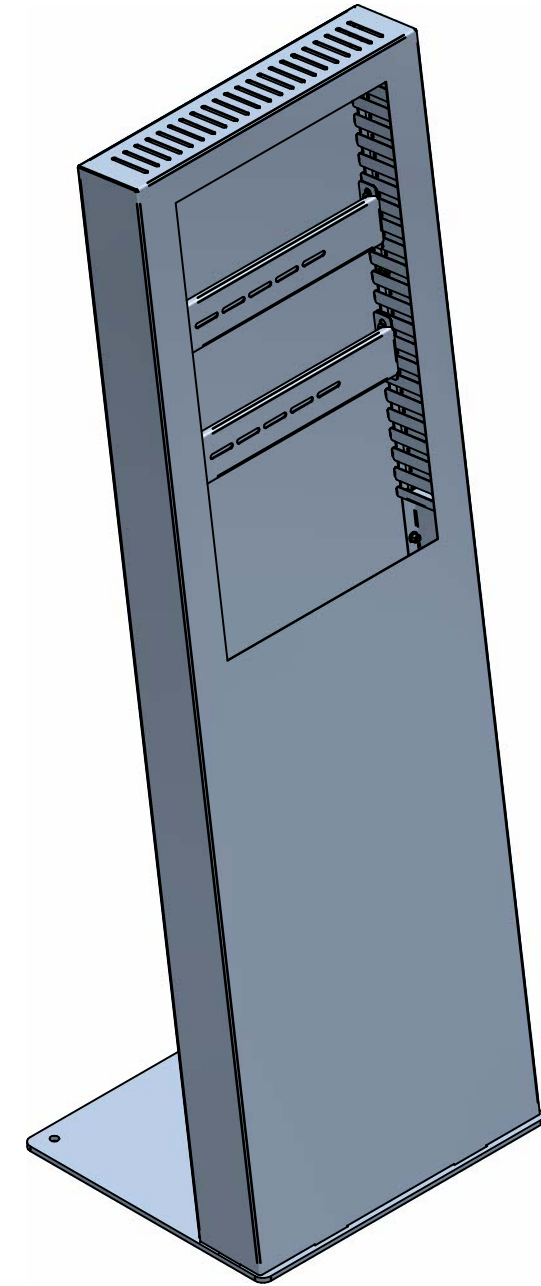
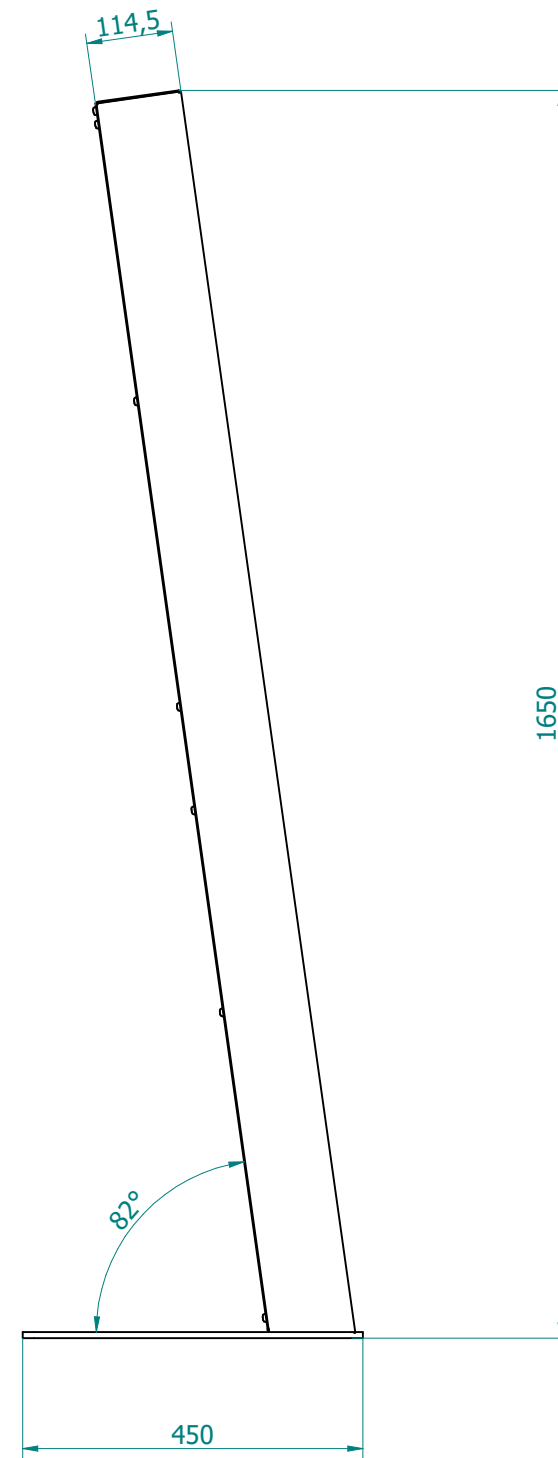
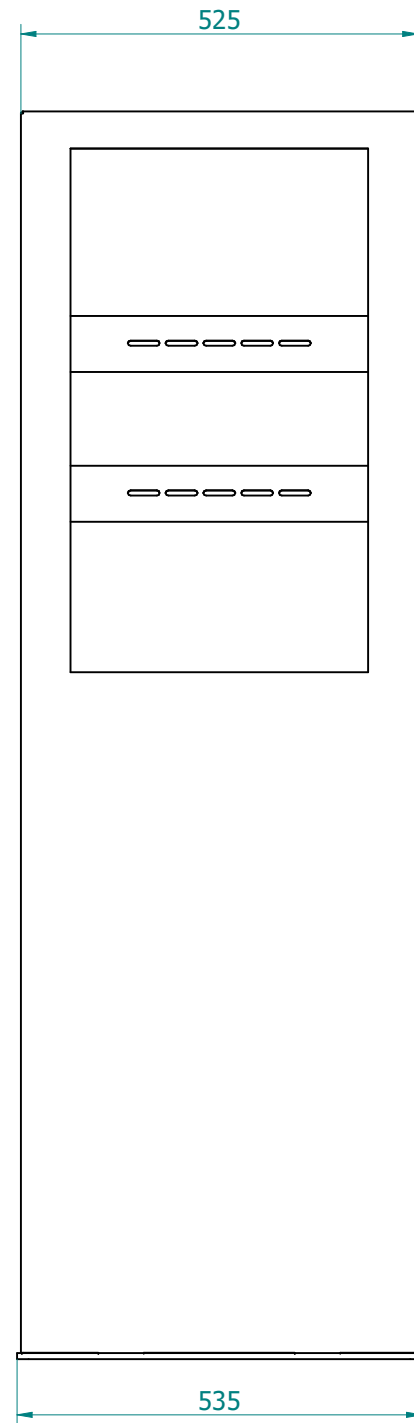

Chamfers not indicated 0,5x45°	Roughness	General tolerances For linear dimensions: ±0.1 mm For angular dimensions: ISO 2768-m	Weight [kg] 41.04 kg	Scale 1/1	
 TARGETED TO PROFESSIONALS		Created by Trabucco Marco	Date of issue 25/07/2025		
Code name/File name 09290-C01		Title/Supplementary title Totem Sigma 32"		Sheet 1\3	Paper size A3
Proprietà di O.M.B. SRL - Senza autorizzazione scritta della stessa il presente disegno non potrà essere utilizzato per la costruzione dell'oggetto rappresentato né venire comunicato a terzi.					

Rev.	Date of issue	Description	Sign
0001	25/07/2025	First edition	T.M.

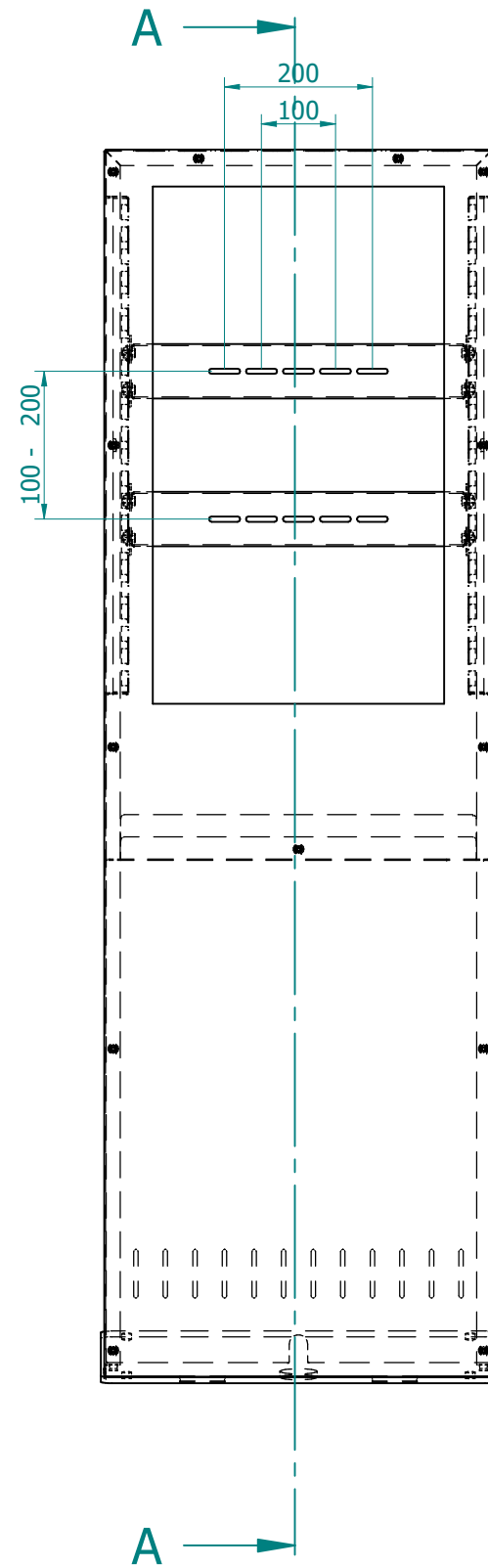

Min. 20, - Max. 72,5

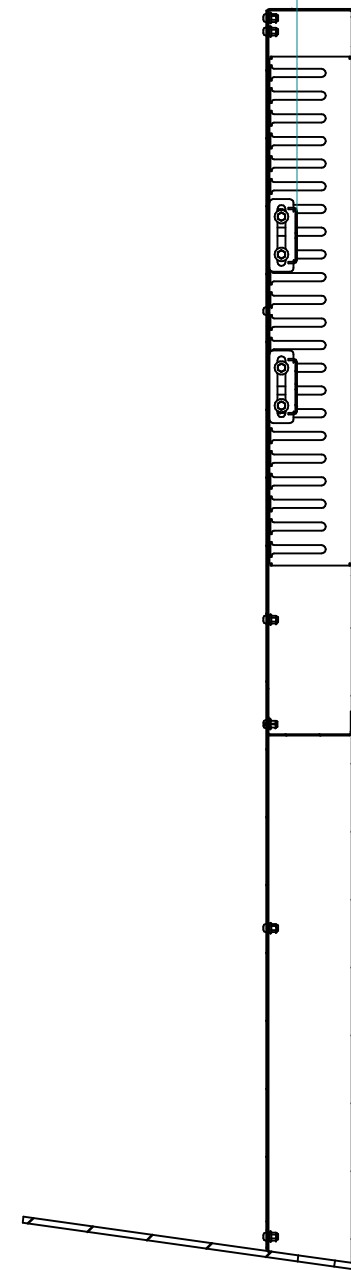

SEZIONE A-A

Chamfers not indicated 0,5x45°	Roughness	General tolerances For linear dimensions: ±0.1 mm For angular dimensions: ISO 2768-m	Weight [kg] 41.04 kg	Scale 1/1	
		Created by Trabucco Marco	Date of issue 25/07/2025		
		Title/Supplementary title Totem Sigma 32"			
Code name/File name 09290-C01					Sheet 2\3
Proprieta' di O.M.B. SRL - Senza autorizzazione scritta della stessa il presente disegno non potra' essere utilizzato per la costruzione dell'oggetto rappresentato ne venire comunicato a terzi.					Paper size A3

Rev.	Date of issue	Description	Sign
0001	25/07/2025	First edition	T.M.

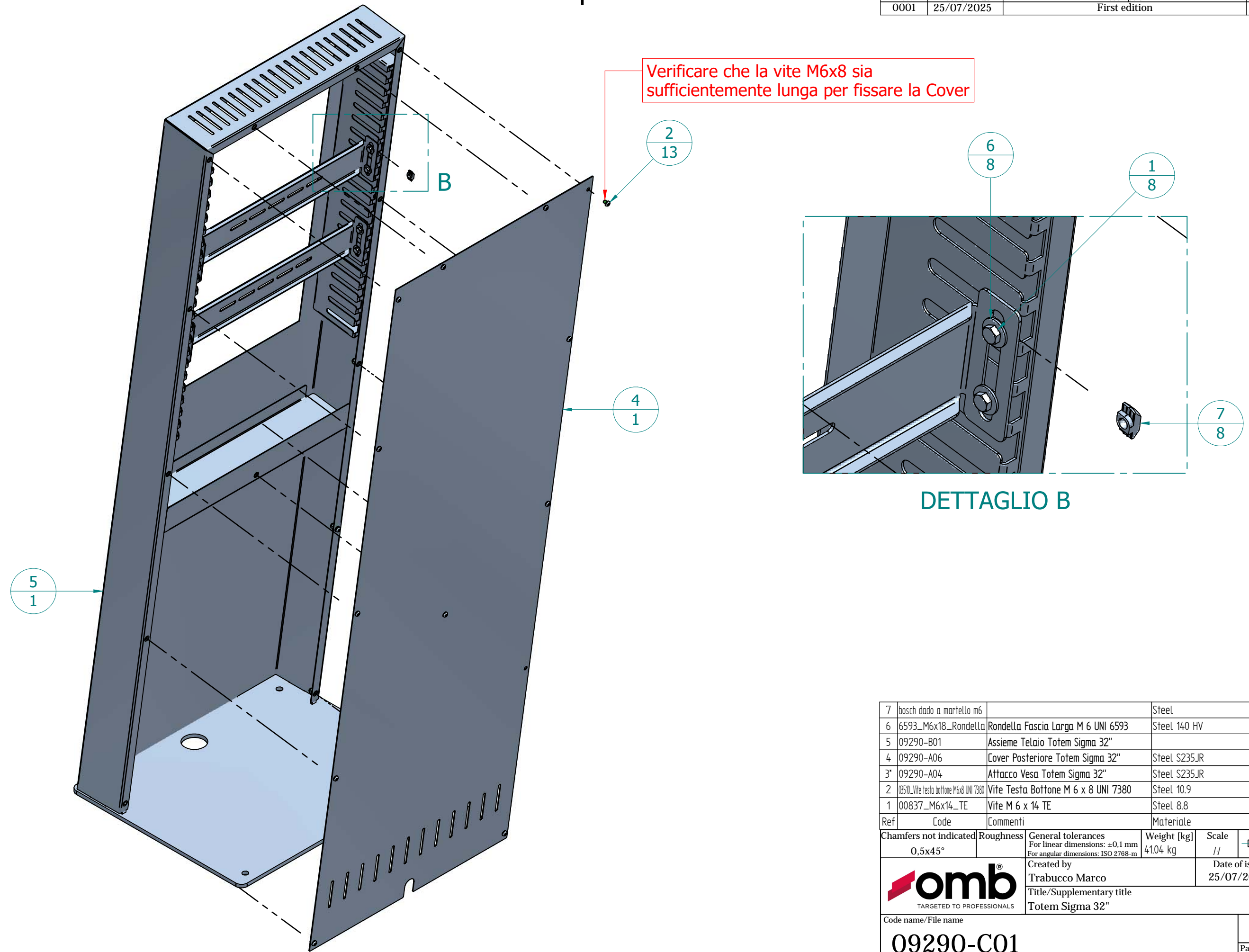

Verificare che la vite M6x8 sia sufficientemente lunga per fissare la Cover

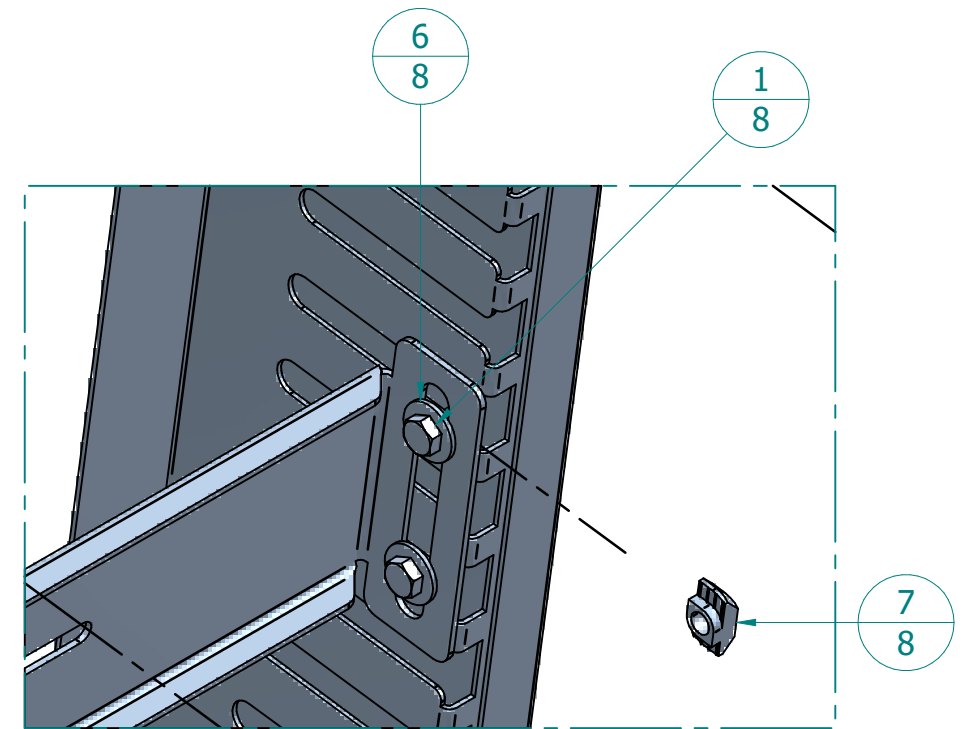

DETTAGLIO B

7	bosch dado a martello m6		Steel	8
6	6593_M6x18_Rondella	Rondella Fascia Larga M 6 UNI 6593	Steel 140 HV	8
5	09290-B01	Assieme Telaio Totem Sigma 32"		1
4	09290-A06	Cover Posteriore Totem Sigma 32"	Steel S235JR	1
3	09290-A04	Attacco Vesa Totem Sigma 32"	Steel S235JR	2
2	03510_Vite testa bottone M6x8 UNI 7380	Vite Testa Bottone M 6 x 8 UNI 7380	Steel 10.9	13
1	00837_M6x14_TE	Vite M 6 x 14 TE	Steel 8.8	8
Ref	Code	Commenti	Materiale	Q.ty

Chamfers not indicated 0,5x45°	Roughness	General tolerances For linear dimensions: ±0.1 mm For angular dimensions: ISO 2768-m	Weight [kg] 41.04 kg	Scale 1/1	
		Created by Trabucco Marco	Date of issue 25/07/2025		
Code name/File name 09290-C01		Title/Supplementary title Totem Sigma 32"		Sheet 3\3	Paper size A3
Proprietà di O.M.B. SRL - Senza autorizzazione scritta della stessa il presente disegno non potrà essere utilizzato per la costruzione dell'oggetto rappresentato né venire comunicato a terzi.					