

dvLED FLOOR TO WALL  
PROFESSIONAL DISPLAY SUPPORT

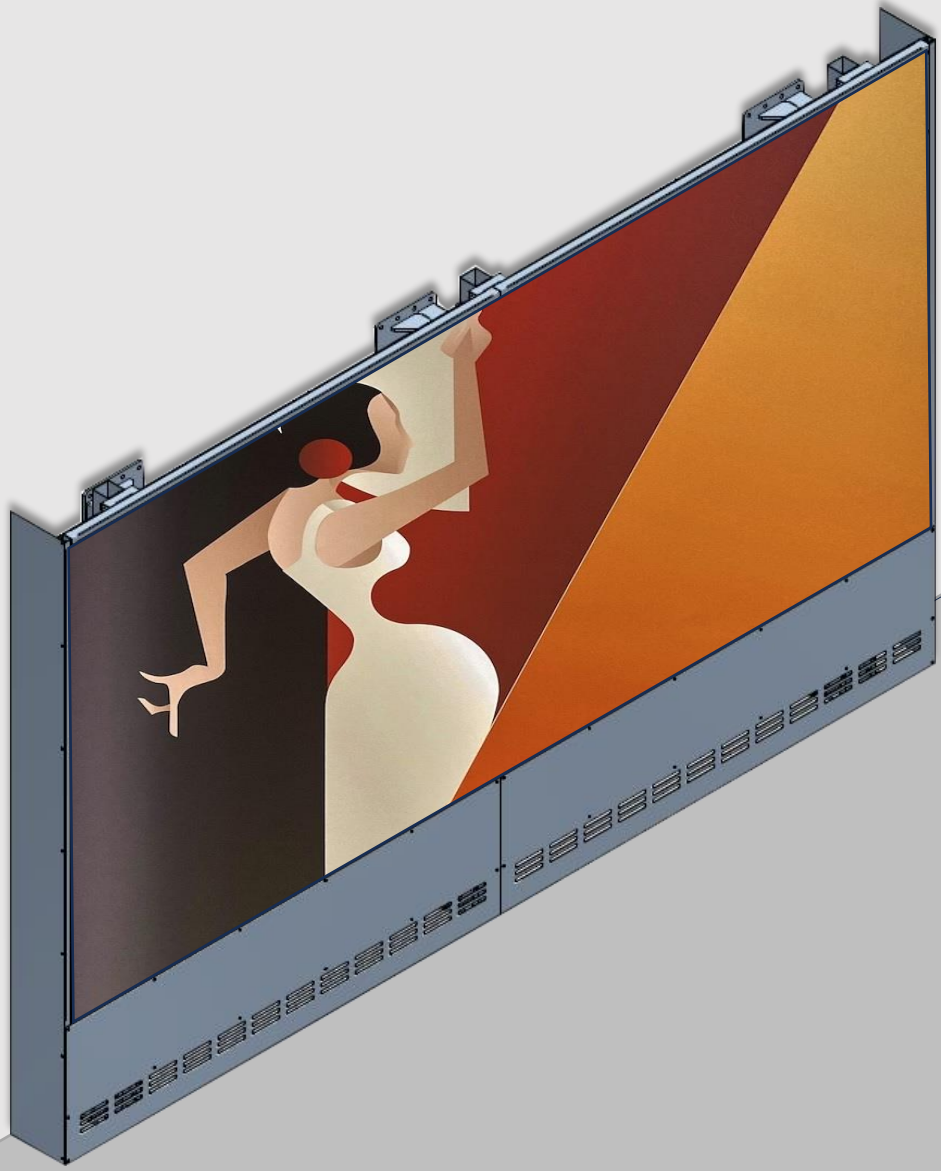

The dvLED structures are customized based on the total size of the LED and the model/brand of tile used

This solution is designed to guarantee perfect alignment of the LED tiles, thanks to the adjustments of the X, Y and Z axes.

If necessary, metal covers can be created between the floor and the LED base line.

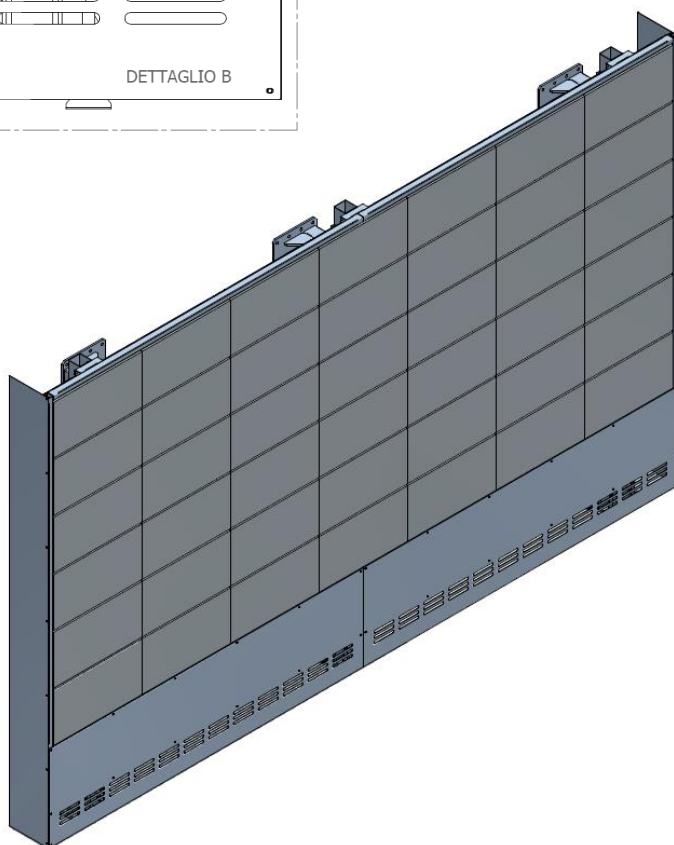
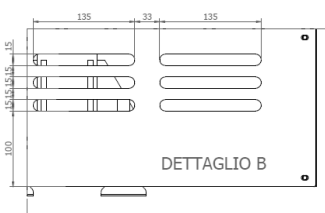
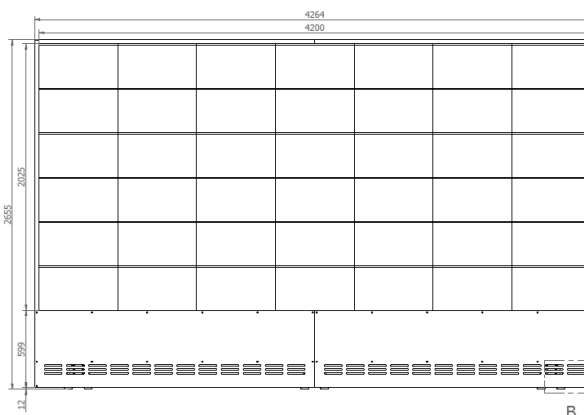
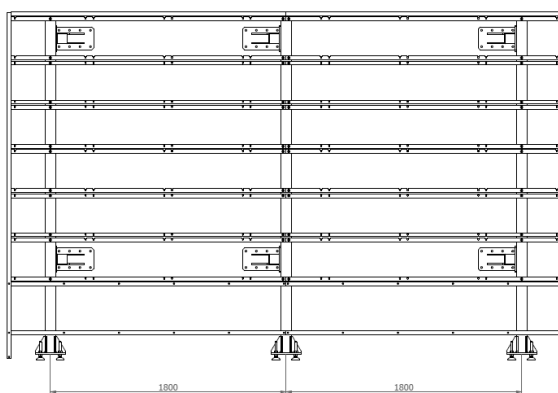

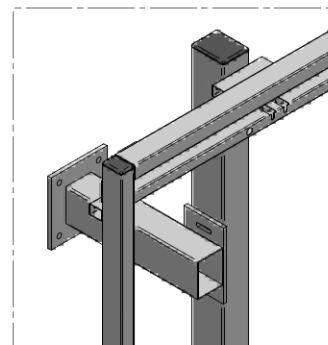
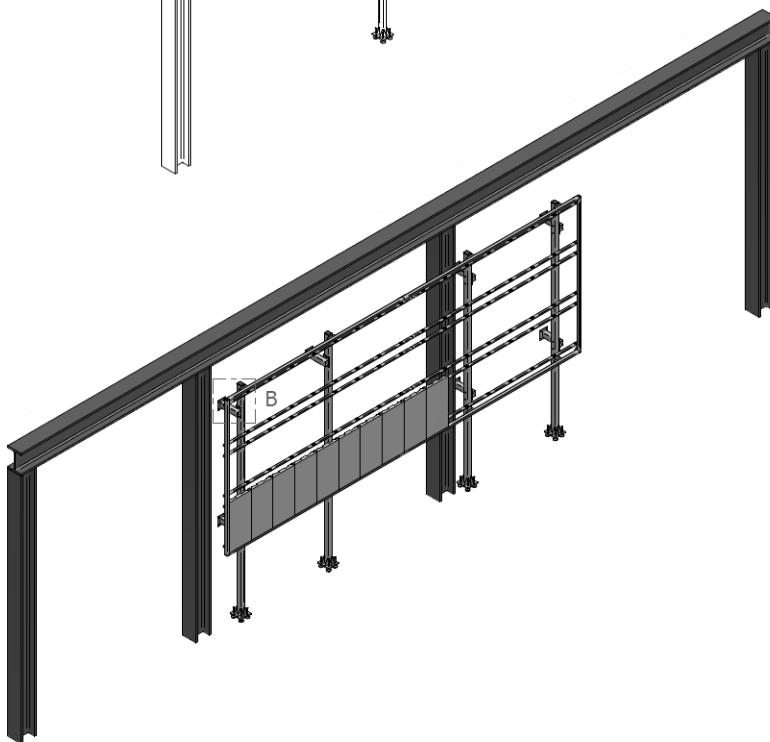
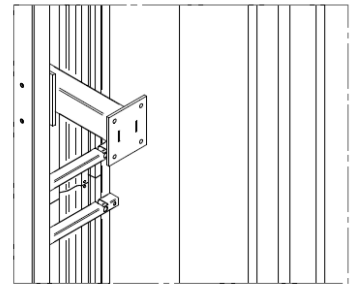
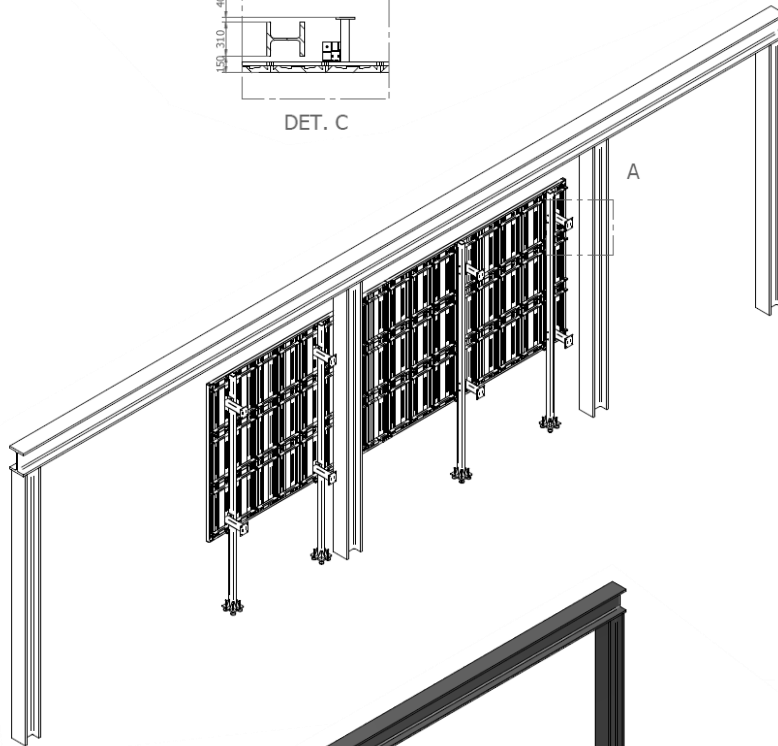
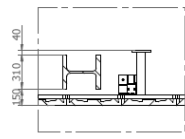
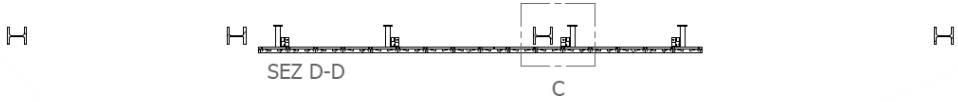
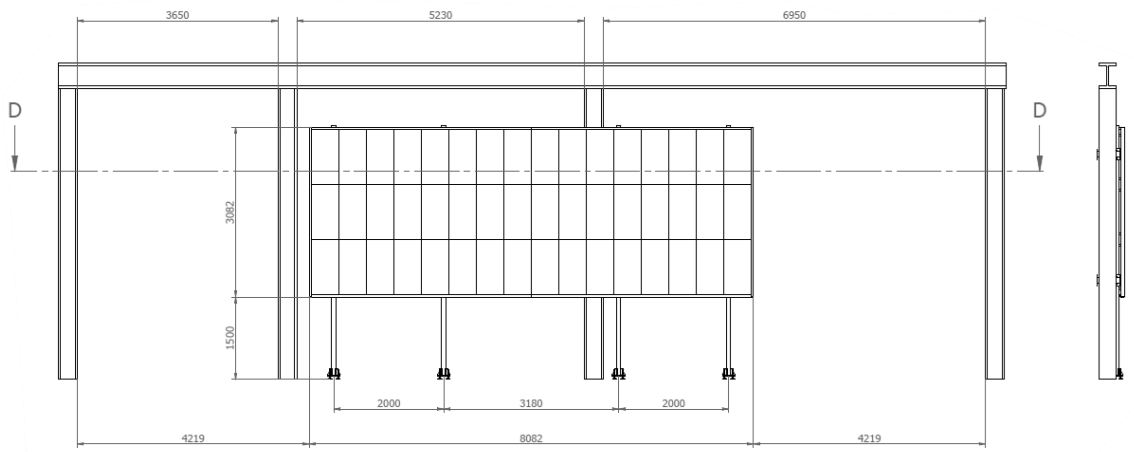



OMB srl | Via Risorgimento, 25 | 38070 STENICO (TN) | ITALY  
Tel. +39 0465 771036 | [omb@ombitaly.it](mailto:omb@ombitaly.it) | [www.ombitaly.it](http://www.ombitaly.it)